































# E-series/E1000-series Cable Guide

## Overview

### NOTE!

- All RS422 cables can be used for E-series and E1000-series!
- To use the E-series RS232 cables for E1000-series, the adapter **CAB12** has to be used!
- Cables for E1000 start at CAB30!

---

 Cab01 (S5).pdf
 Cab02 (Allen Bradley Micrologix RS232C).pdf
 Cab03 (OMRON C51).pdf
 Cab04 (GE Fanuc RS422).pdf
 Cab05 (MAC E Programming cable).pdf
 Cab06 (RS422 changer).pdf
 Cab07 (Siemens S5 RS422).pdf
 Cab08 485 Adapter.pdf
 Cab08 Cable diagram.pdf
 Cab09 (FREQROL FR-E_A RJ45).pdf
 Cab10 (Allen Bradley DH485 RJ45port).pdf
 Cab11 (HMI Adapter).pdf
 Cab12 (RS232 Adapterpiece).pdf
 Cab13 (Melservo MR-J2).pdf
 Cab14 (RS232 Matsushita FP0 PLC).pdf
 Cab15 (CANopen adapter drawing).pdf
 Cab16 (System Q RS232).pdf
 Cab17 (System Q RS422).pdf
 Cab18 (MAC40-CPU-CAB-R4).pdf
 Cab19 (RS422 FX2N Programming port).pdf
 Cab20 (S7-200 RS422).pdf
 Cab21 (Extended Keyboard RS232).pdf
 Cab22 (Extended Keyboard RS422).pdf
 Cab23 (Extension for Cab15).pdf
 Cab30 (E1000 programming cable).pdf
 Cab31 (E1000 AB Micrologix).pdf
 Cab32 (E1000 OMRON C_C51).pdf
 Cab33 (E1000 Matsushita FP0_M_2_25H).pdf
 Cab34 (E1000 MELSEC SystemQ RS232).pdf
 Cab36 (E1000 MPI Direct).pdf

## CAB1 (Stock No 124261)

### E-Series RS 232 to Siemens S5 PG using Siemens converter 6ES5 734-1BD20

25 pin D-sub (male) to 9 pin D-sub (female). The cable length is 0.5 m. The Siemens converter 6ES5 734-1BD20 (0.3m) must be used with this cable. The converter is connected to the programming port (PG) of the Siemens SIMATIC S5. The 25 pin D-sub connector of the CAB 1 cable is connected to the Siemens converter. The 9 pin D-sub connector of the CAB 1 cable is connected to the RS232C port of the operator terminal.

### (Drawing 03305)

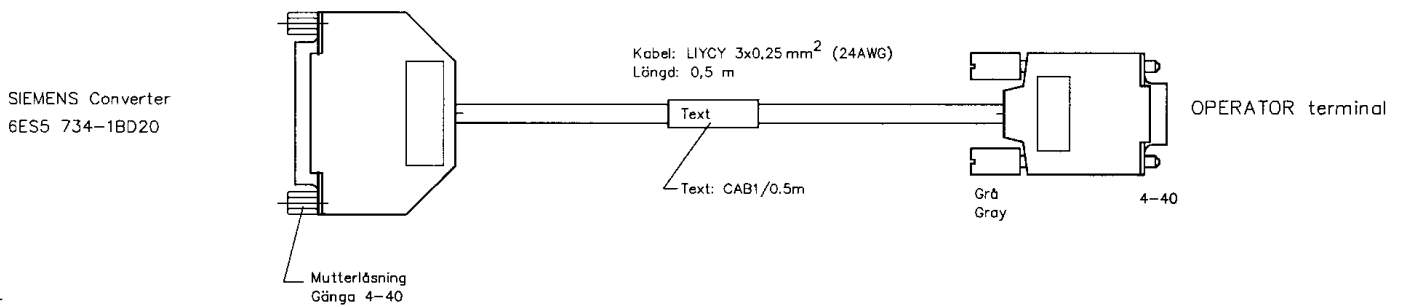

25-pol D-sub Hane  
25-pin D-sub Male

9-pol D-sub Hona  
9-pin D-sub Female

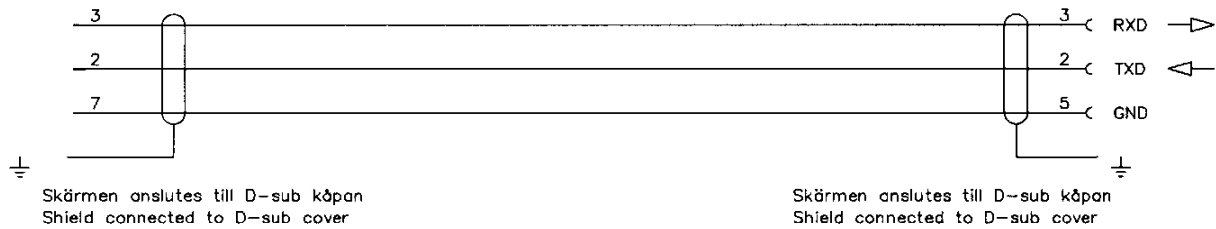

# CAB2 (Stock No 124262)

## E-Series RS232 to Allen Bradley Micrologix

8 pin MiniDin (male) to 9 pin D-sub connector (female). The cable length is 2 m. The MiniDin connector is connected to the Allen Bradley Micrologix programming port and the D-sub connector is connected to the RS232C port of the operator terminal.

### (Drawing 03301)

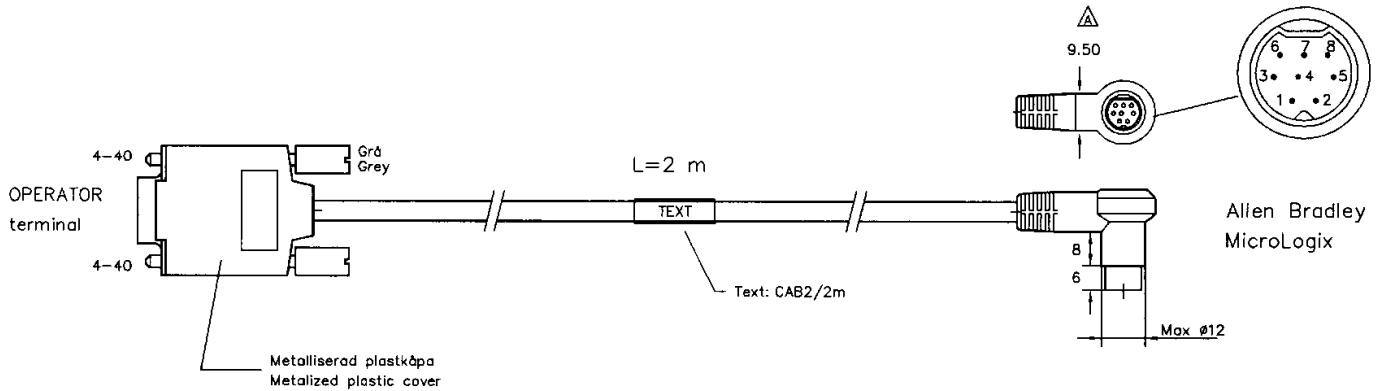

RS-232

9-pol D-sub Hona  
9-pos D-sub Female

RS-232

8-pol minidin  
8-pos minidin

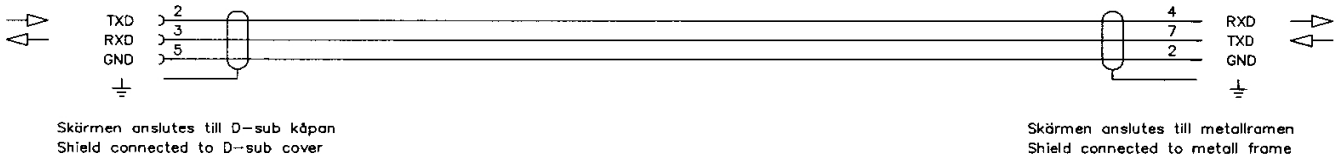

# CAB3 (Stock No 124263)

## E-Series RS232 to Omron C/CS1

9 pin D-sub (male) to 9 pin D-sub (female). The cable length is 3 m. The 9 pin D-sub connector (male) is connected to the OMRON C/CS1 and the 9 pin D-sub connector (female) is connected to the RS232C port of the operator terminal.

### (Drawing 03304)

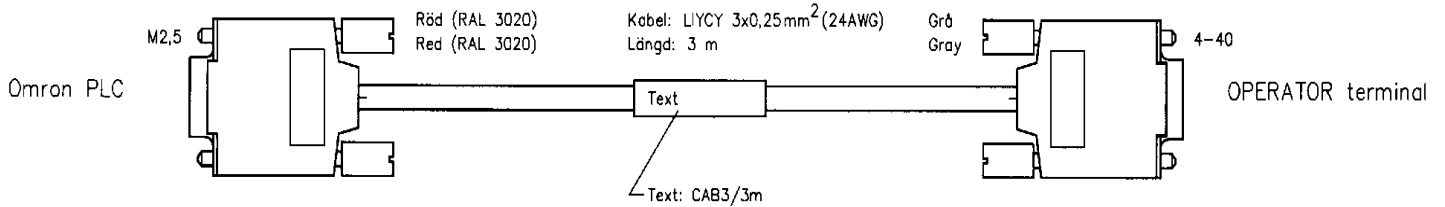

9-pol D-sub Hane  
9-pin D-sub Male

9-pol D-sub Hona  
9-pin D-sub Female

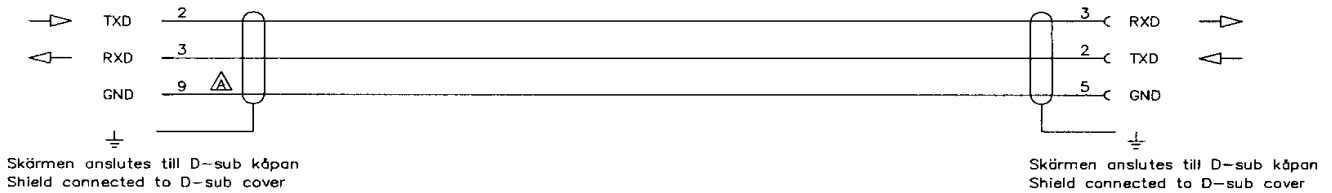

# CAB4 (Stock No 124264)

## E-Series RS422 to GE Fanuc

25 pin D-sub (male) to 15 pin D-sub (male). The cable length is 3 m. The 25 pin D-sub connector is connected to the RS422 port of the operator terminal and the 15 pin D-sub connector is connected to the GE FANUC Series 90.

### (Drawing 03302)

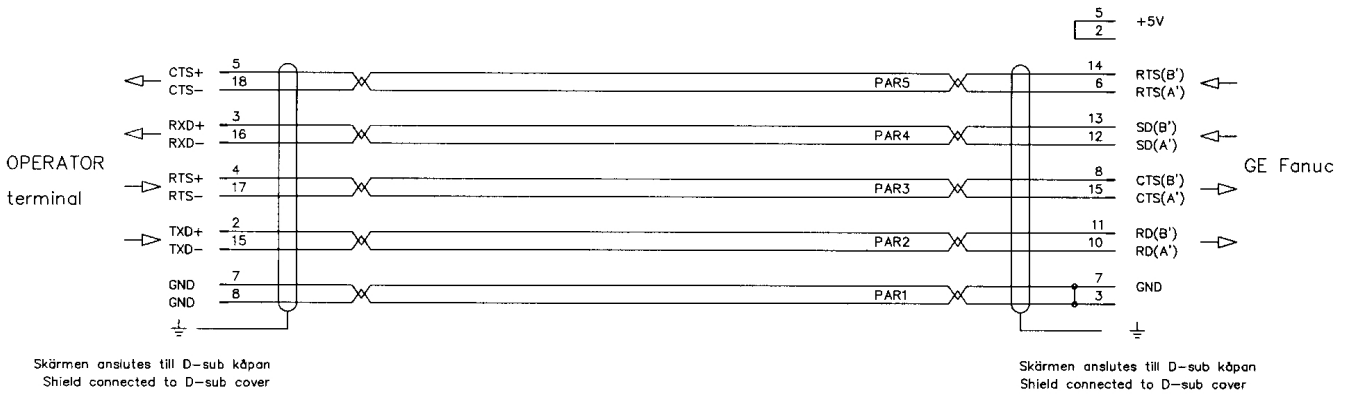
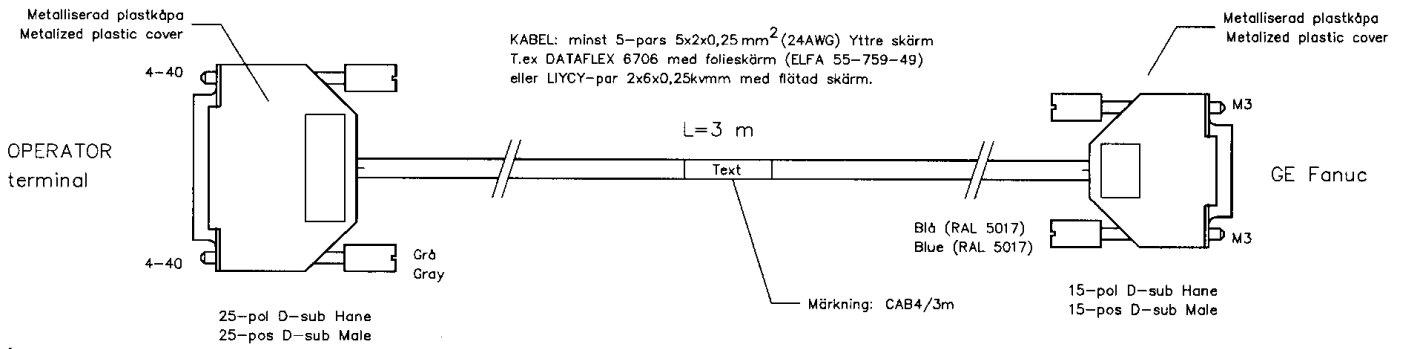

## CAB5 (Stock No 124265) General Purpose Cable

9 pin D-sub (female) to 9 pin D-sub (female). The cable length is 2.5 m. The CAB5 cable can be used in eleven different ways:

(1) In this case the CAB5 cable is used as a **programming cable** between a computer (PC) and an operator terminal. The black D-sub connector of the CAB5 cable is connected to the RS232C port of the operator terminal and the grey connector of the CAB5 cable is connected to one of the communication ports (COM 1/COM 2) of the computer.

(2) In this case the CAB5 is connected between an operator terminal and an **FX1N-232BD or FX2N-232BD**. The black D-sub connector of the CAB5 cable is connected to the RS232C port of the operator terminal and the grey connector of the CAB5 cable is connected to FX1N-232BD or FX2N-232BD.

(3) In this case the CAB5 cable is connected between the **MPI port of a SIMATIC S7-300/400** and an operator terminal. The adapter cable CAB11 MPI must be used with the CAB5 (Note: CAB 11 MPI cable length is 1.2 m). The CAB11 D-sub cable is connected to the MPI port of the SIMATIC S7, the other D-sub connector of the adapter is connected to the grey connector of the CAB5. The black connector of the CAB5 is then connected to the RS232C port of the operator terminal.

**Note:** Not all operator terminals support the MPI protocol. Please refer to the driver list in the programming software for further information.

(4) In this case the CAB5 cable is connected between Siemens **SIMATIC S7/-300/400 PLCs** and the RS232C port of the operator terminal. SIMATIC S7/-300/400 must be supplemented with the **communication card CP341**. The black D-sub connector of the CAB5 cable is connected to the RS232C port of the operator terminal and the grey connector of the CAB5 cable is connected to the RS232C port of the communication card CP341.

(5) In this case the CAB5 cable is connected between Siemens **SIMATIC S5** (all models) and the RS232C port of the operator terminal. SIMATIC S5 must have the communication card **CP525** installed. The black D-sub connector of the CAB5 cable is connected to the RS232C port of the operator terminal and the grey connector of the CAB5 cable is connected to the RS232C port of the CP525 communication card.

(6) In this case the CAB5 cable is connected between the **Allen Bradley ControlLogix** and the RS232C port of the operator terminal. The black D-sub CP525 of the CAB5 cable is connected to the RS232C port of the operator terminal and the grey CP525 of the CAB5 cable is connected to the Allen Bradley ControlLogix.

(7) In this case the CAB5 cable is connected between the **Allen Bradley SLC 500, SLC 5/01, SLC 5/02, SLC 5/03, SLC 5/04 or SLC 5/05 PLCs** and the RS232C port of the operator terminal. When connecting the systems SLC 500, SLC 5/01 and SLC 5/02, the cable 1747-C13 and the module 1747-KE from Allen Bradley must be used in conjunction with the CAB5 cable. The black D-sub connector of the CAB5 cable is connected to the RS232C port of the operator terminal and the grey connector of the CAB5 cable is connected to the 1747-KE module. The cable 1747-C13 is then connected between the 1747-KE module and the DH485 port of the Allen Bradley PLC system. The PLC systems SLC 5/03, SLC 5/04 and SLC 5/05 can be directly connected with the CAB5 cable by using the RS232C port of the PLC-system, it is recommendation however to use the Allen Bradley 1747-KE module due to it's galvanic isolation on the port.

(8) In this case the CAB5 cable is connected between the **B&R 2000 Series (Mininet)** and the E-terminals. The black D-sub connector of the CAB5 cable is connected to the RS232C port of the operator terminal and the grey connector of the CAB5 cable is connected to the PLC-system.

(9) In this case the CAB5 cable is connected between a **PC running Steeplechase VLC** and an E-Series. The black D-sub connector of the CAB5 cable is connected to the RS232C port of the operator terminal and the grey connector of the CAB5 cable is connected to the Steeplechase VLC host computer's RS232 port.

(10) In this case the CAB5 cable is connected between a **VT100** and the terminals. The black D-sub connector of the CAB5 cable is connected to the RS232C port of the operator terminal and the grey connector of the CAB5 cable is connected to the RS232 port of a VT100.

(11) In this case the CAB5 cable is connected between the RS232 port of the E-terminal and the RS232 port of the **Mitsubishi A1SJ71(Q,U)C24(-R2) and QJ71C24-R2 module**.

(Drawing 03300)

OPERATOR terminal

PC

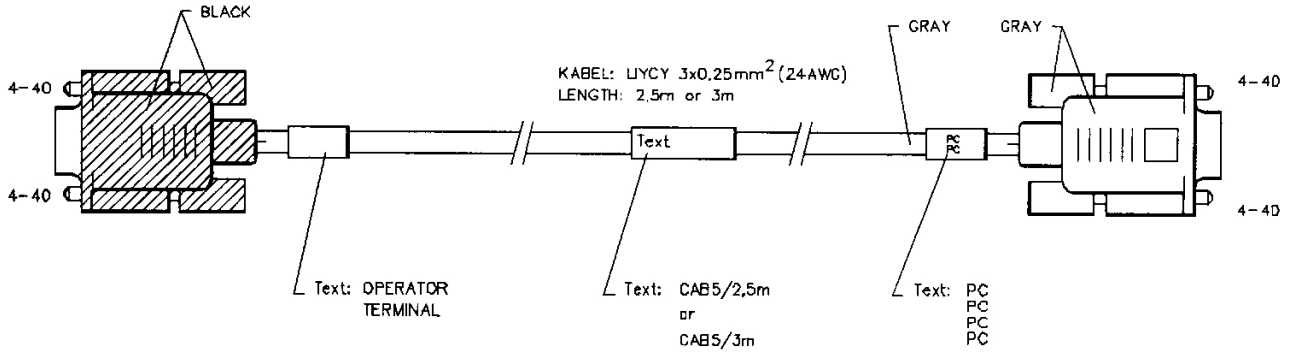

RS-232

RS-232

9-pin D-sub Male  
9-pin D-sub Female

9-pin D-sub Male  
9-pin D-sub Female

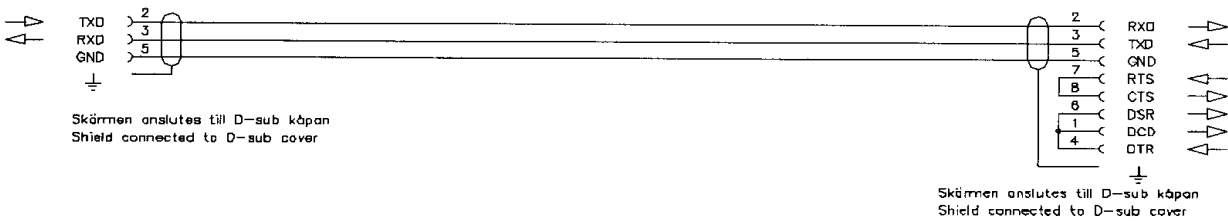

# CAB6 (Stock No 124266)

## RS422 to RS232 converter

25 pin D-sub (male) to 9 pin D-sub (female). The cable length is 3 m. The CAB6 can be used in six different ways:

- 1) In this case the CAB6 cable is used as a **programming cable** between a Computer (PC) and the operator terminals. The 25 pin D-sub connector is connected to the RS422 port of the operator terminal and the 9-pin D-sub connector is connected to one of the RS232 communication ports (COM 1/COM 2) of the computer.
- 2) In this case the CAB6 cable is connected between an **Allen Bradley ControlLogix** and the RS422 port of the operator terminal. The 25 pin D-sub connector is connected to the RS422 port of the operator terminal and the 9 pin D-sub connector is connected to the Allen Bradley PLC programming port.
- 3) In this case the CAB6 cable is connected between the **MPI port of a SIMATIC S7-300/400** and an operator terminal. In this case the adapter cable CAB11 MPI must be used with the CAB6 cable (Note: The CAB 11 MPI cable length is 1.2 m). The CAB11 D-sub connector cable is connected to the MPI port of the SIMATIC S7. The other D-sub connector of the adapter is connected to the 25 pin D-sub connector of the CAB6 cable. The 9 pin D-sub connector of the CAB6 cable is then connected to the RS422 port of the operator terminal.
- 4) In this case the CAB6 cable is connected between the **B&R 2000 series (Mininet)** and the RS422 port of the operator terminal. The 25 pin D-sub connector is connected to the RS422 port of the operator terminal and the 9 pin D-sub connector is connected to the PLC-system.
- 5) In this case the CAB6 cable is connected between a **PC running Steeplechase VLC** and the RS422 port of the operator terminal. The 25 pin D-sub connector is connected to the RS422 port of the operator terminal and the 9 pin D-sub connector is connected to the Steeplechase VLC host computer's RS232 port.
- 6) In this case the CAB6 cable is connected between a **VT100** and the RS422 port of the operator terminal. The 25 pin D-sub connector is connected to the RS422 port of the operator terminal and the 9 pin D-sub connector is connected to the VT100's RS232 port.

### (Drawing 03307)

Operator terminal

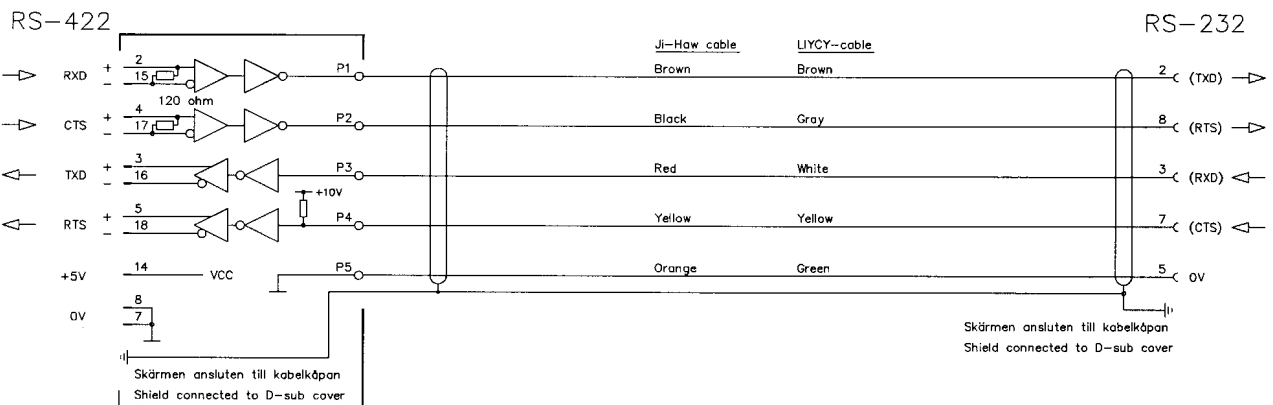
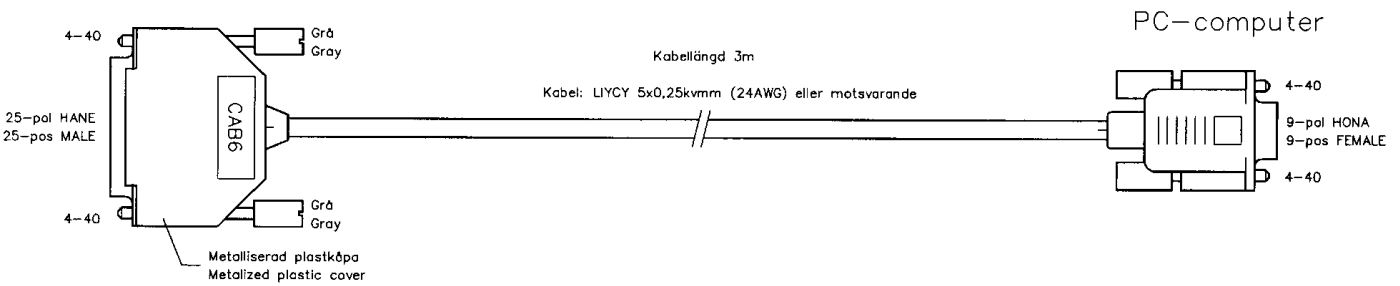



# CAB7 (Stock No 124267)

## E-Series RS422 to SIMATIC S5 Programming port

15 pin D-sub (male) to 25 pin D-sub (male). The cable length is 3 m. The 15 pin D-sub connector is connected to the programming port (PG) of the Siemens SIMATIC S5 and the 25 pin D-sub connector is connected to the RS422 port of the operator terminal.

### (Drawing 03311)

Siemens PLC  
20 mA current loop

Operator terminal  
RS-422

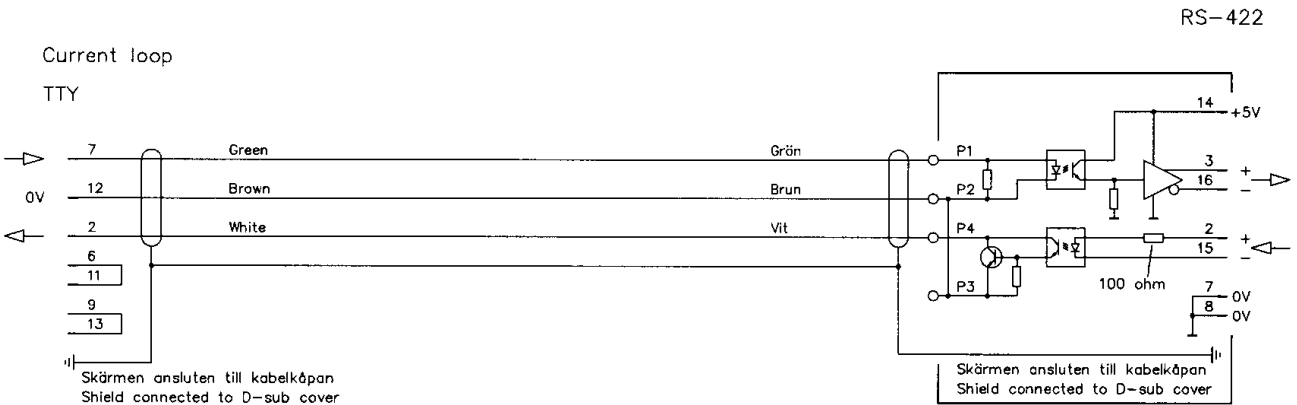
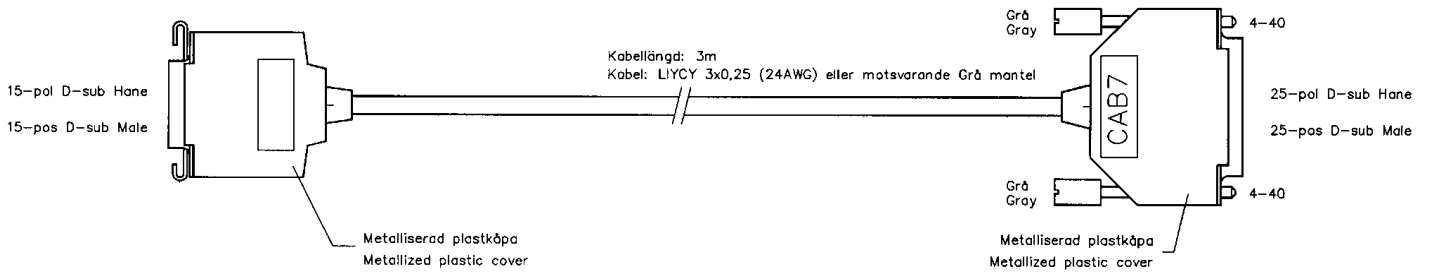

# CAB8 (Stock No 124268)

## RS422 to RS485 converter

25 pin D-sub connector (male) to a connection block. CAB8 is an adapter that converts RS422 to RS485. The CAB 8 can be used to connect Siemens SIMATIC S7-200 PLCs to the HMIs using the PPI interface. The CAB8 can also be used to connect the E-Terminals to the FX-485 multi-drop network, and also for connecting onto Modbus networks.

### (Drawing 03315)

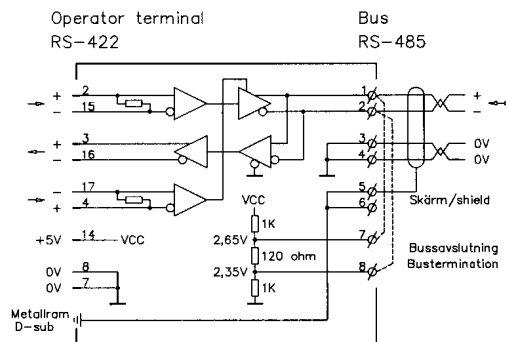
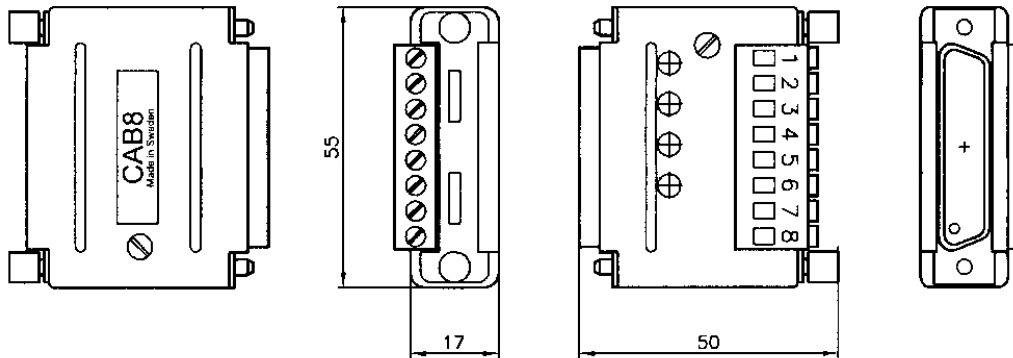

Cable between the PPI port of the Siemens SIMATIC-200 and CAB8

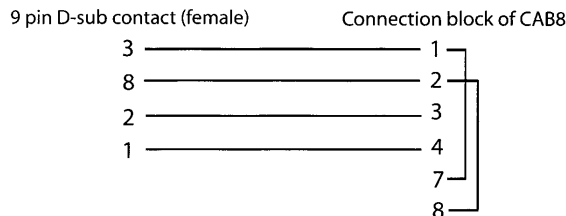

Max cable length = 1200 m

# CAB9 (Stock No 130049)

## E-Series RS422 to Mitsubishi FR-E/A-500 + FR-S-500 Frequency Inverters

Shielded RJ45 connector to a 25 pin D-sub connector (male). The cable length is 3 m. The RJ45 connector is connected to the Mitsubishi FREQROL FR-E/A and the D-sub connector is connected to the RS422 port of the operator terminal.

### (Drawing 03320)

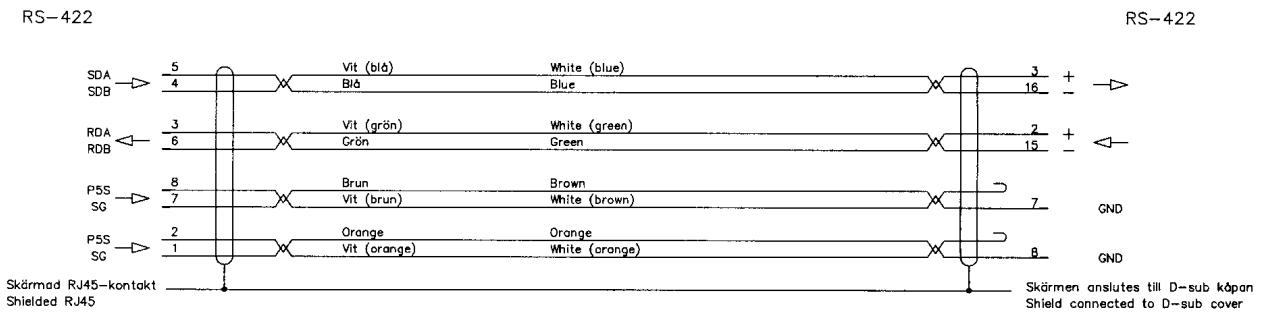
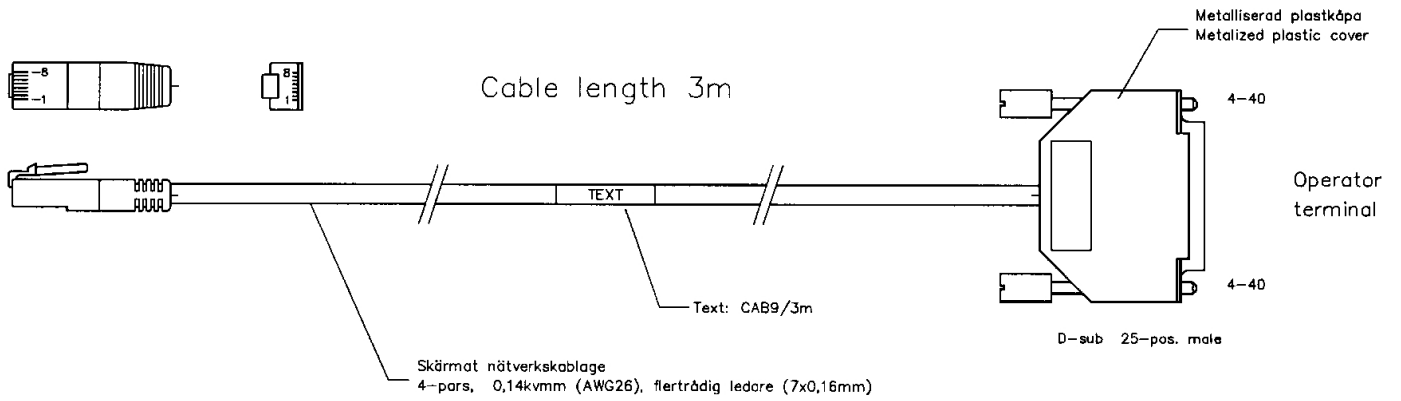

# CAB10 (Stock No 130048)

## E-Series RS422 to Allen Bradley DH485

RJ45 connector to a 25 pin D-sub connector (male). The cable length is 3 m. The RJ45 connector is connected to the DH485 port of an Allen Bradley PLC system and the D-sub connector is connected to the RS422 port of the operator terminal.

### (Drawing 03350)

Operator terminal

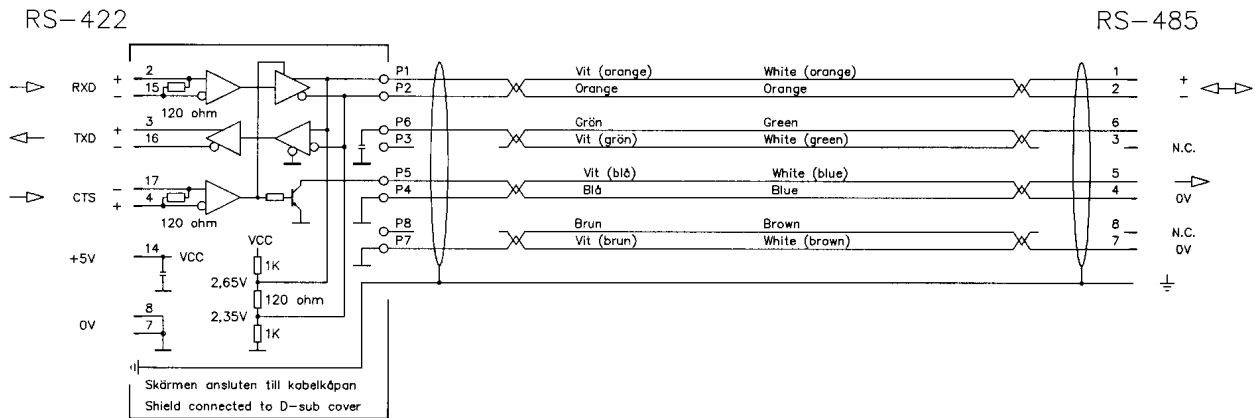
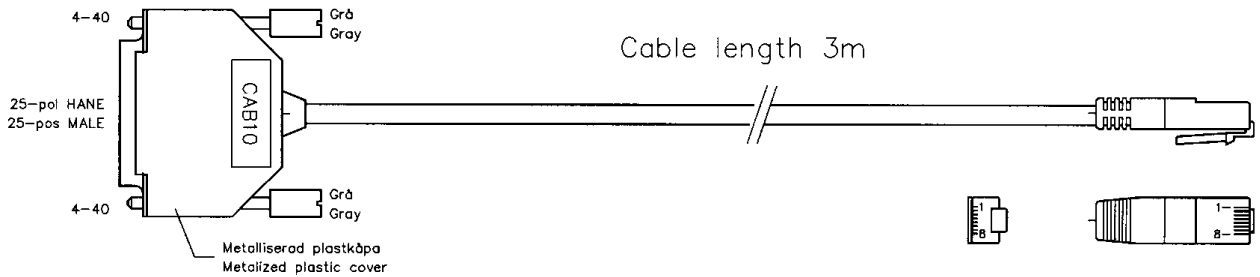

# CAB11 (Stock No 132351)

## E-Series to Siemens S7 MPI

MPI adapter cable with 9 pin D-sub (male) to 9 pin D-sub (male). The cable length is 1.2 m. The cable CAB5 must be used with an adapter cable when using the terminals RS232. The cable CAB6 must be used with an adapter cable when using the terminals RS422. The D-sub adapter end of the cable is connected to the MPI port of the SIMATIC S7-300/400 and the other D-sub connector of the adapter is connected to the grey connector of cable CAB5/CAB6. The black connector of CAB5/CAB6 is then connected to the RS232/RS422 port of the operator terminal.

- LED1 off: The adapter has no power or is faulty
- LED1 on: The adapter is powered up
- LED2 on: The adapter is registered on the MPI network
- LED3 on: The adapter has established a connection on the MPI network
- LED3 flashing: The adapter is transmitting data

Note: Siemens S7-Lite programming software does not support MPI configuration

(Drawing 03359)

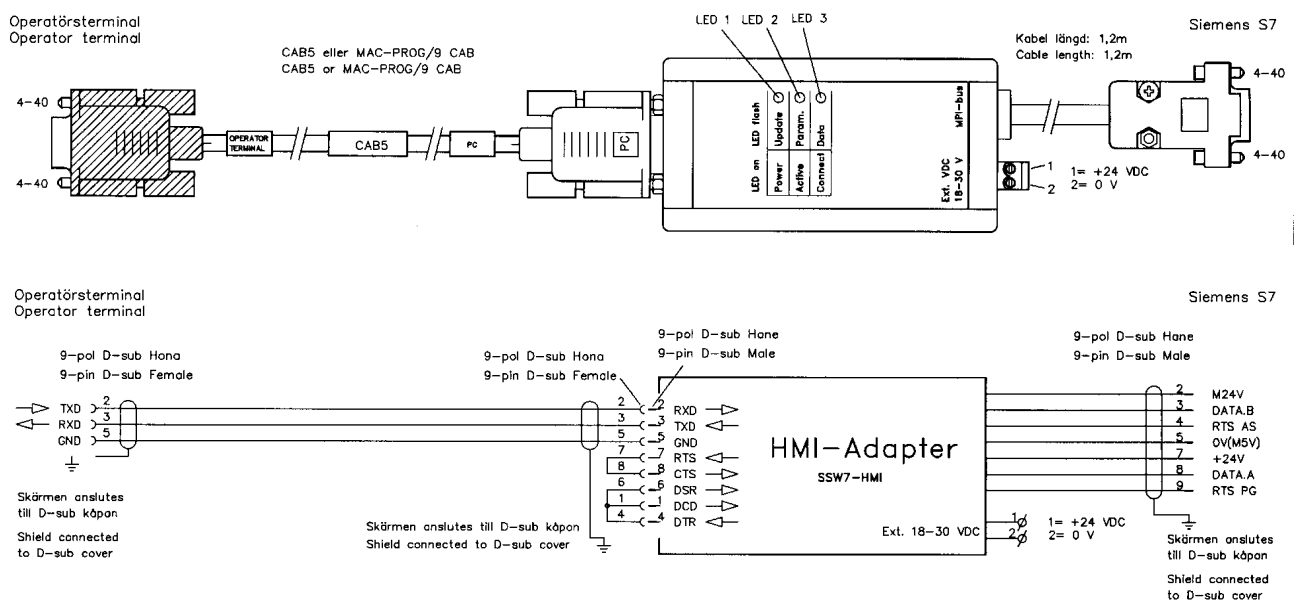

# CAB12 (Stock No 138852)

## RS232 Tx to Rx crossover/ E1000 adapter to E-series cables

Converter for RS232 Tx and Rx signal line crossover. 9 pin female to 9 pin male connector, DTE –DTE, DCE – DCE. This cable allows E-series to be connected to some controllers via a suitable PC programming cable, and is needed when connecting a Palm™ to the HMIs (must be used in conjunction with the Palm™ Serial HotSync® cable ).

- Switch in position 1: RTS/CTS crossed
- Switch in position 2: RTS/CTS open
- Switch in position 3: RTS/CTS looped

### (Drawing 03356)

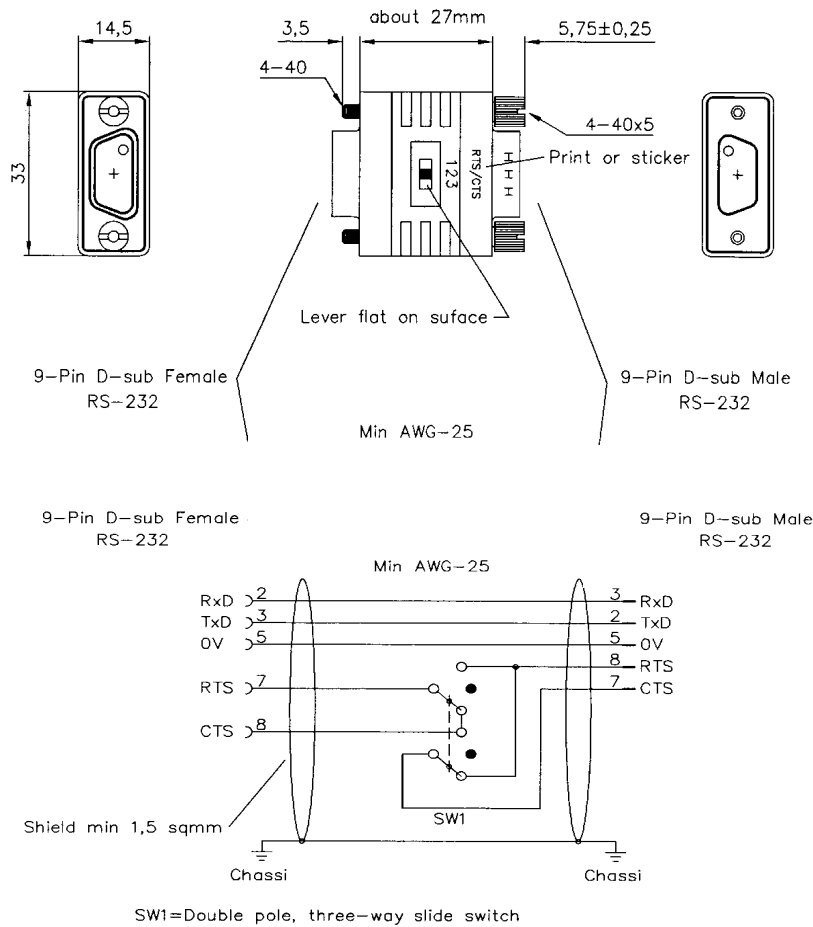

# CAB13 (Stock No 134894=3m version)

## E-Series RS422 to Mitsubishi Melservo MR-J2

20 pin 3M connector (male) to 25-pin D-sub (male). The cable is available in either 3m or 5m versions. The cables 3M connector is connected to the MELSERVO MR-J2 and the D-sub connector is connected to the RS422 port of the E-terminal.

### (Drawing 03361)

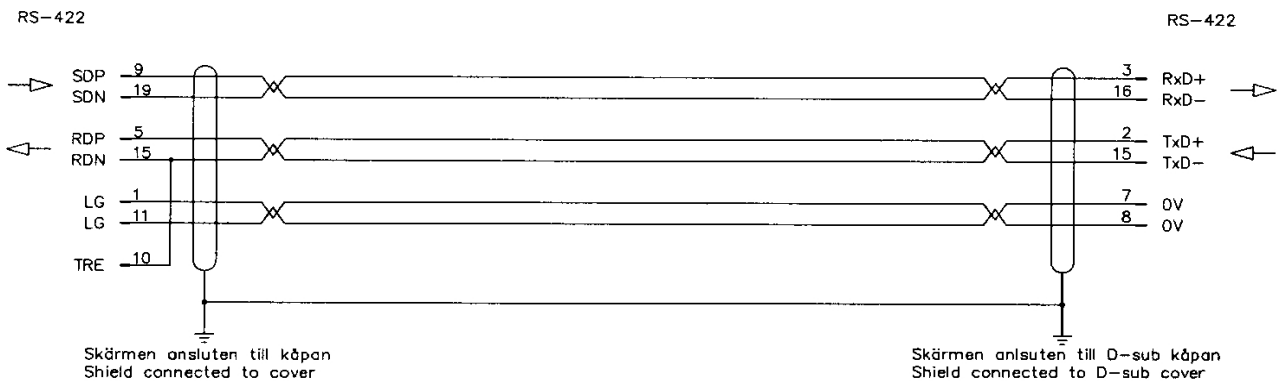
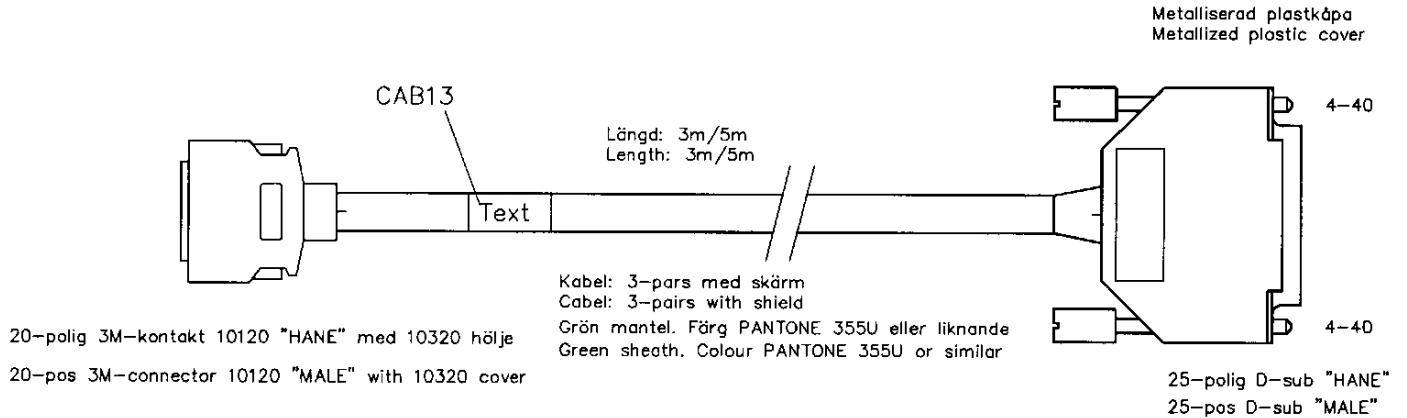

# CAB14

## E-Series RS232 to Matsushita FP0/M/2/2SH

RS232 connector 9 pin D-sub (female) to Mini-DIN5-pin male on PLC side

### (Drawing 04790)

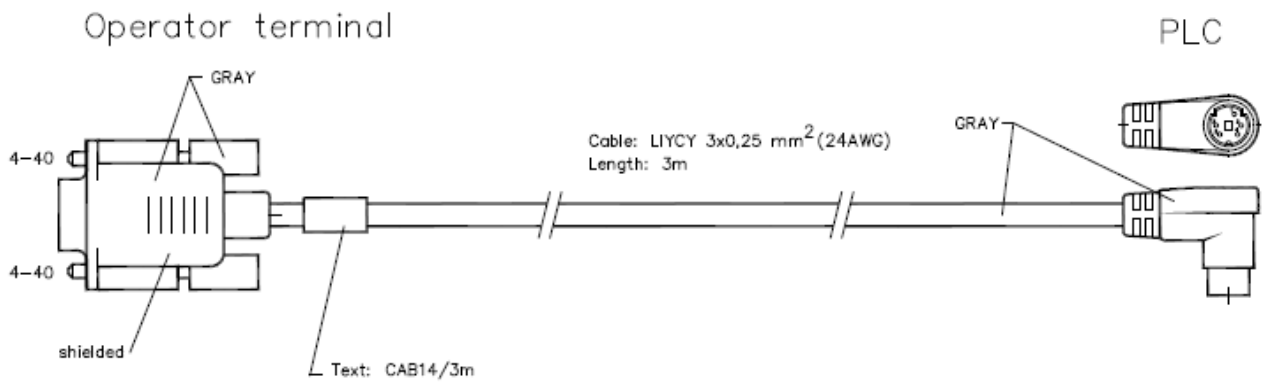
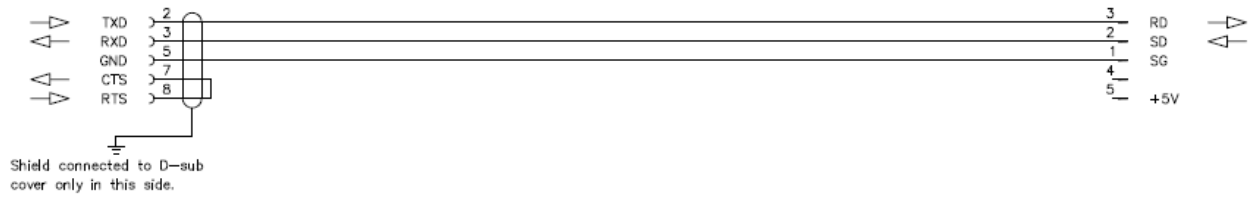



## CAB15 (Stock no 160852)

### E-Series RS422 CANopen adapter

RS422 adapter, 25 pin S-Sub male, can be used in combination with CAB23 as extension cable

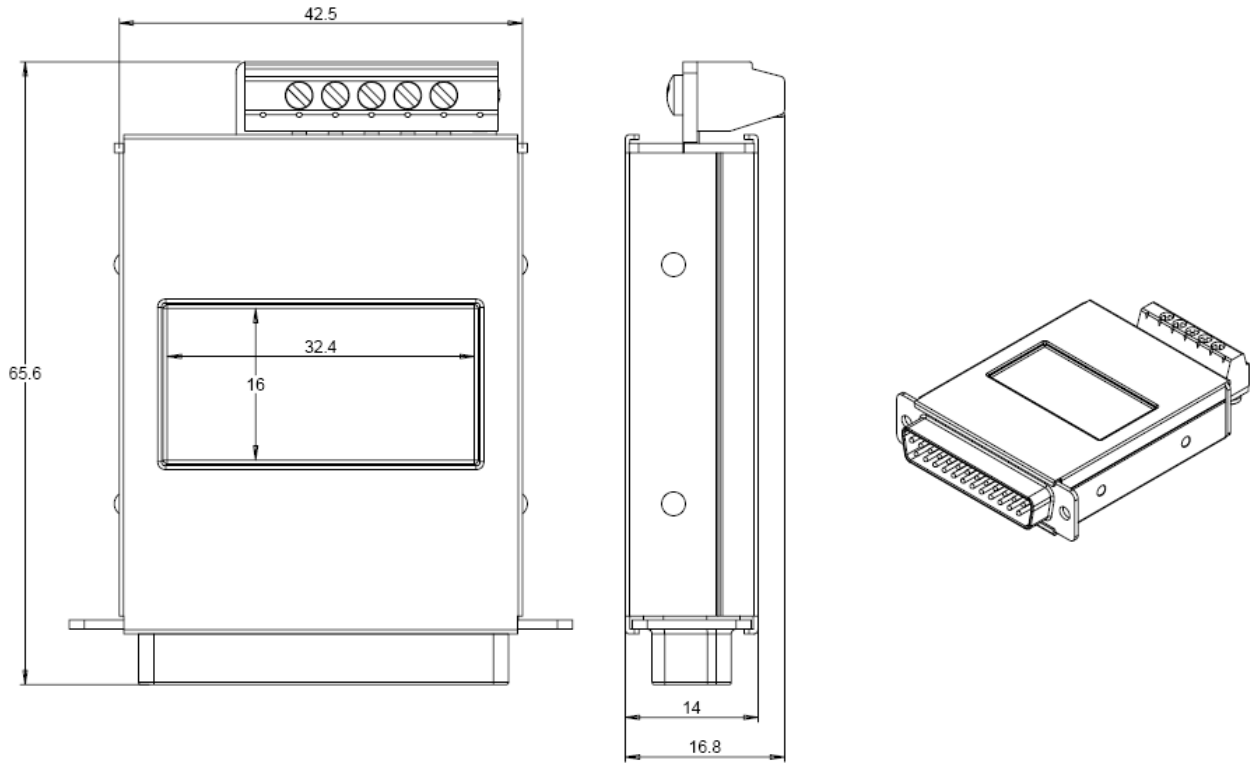

## CAB16 (Stock No 140461=3M length)

### E-Series RS232 to Mitsubishi System Q Series RS232

6 pin MiniDin (male) to 9 pin D-sub (female). The cable is available in the lengths of 1, 3, 5, 7, 10 and 15 m. The MiniDin connector is connected to the PLC CPU's RS232 port and the D-sub connector is connected to the RS232C port of the operator terminal.

#### (Drawing 03363)

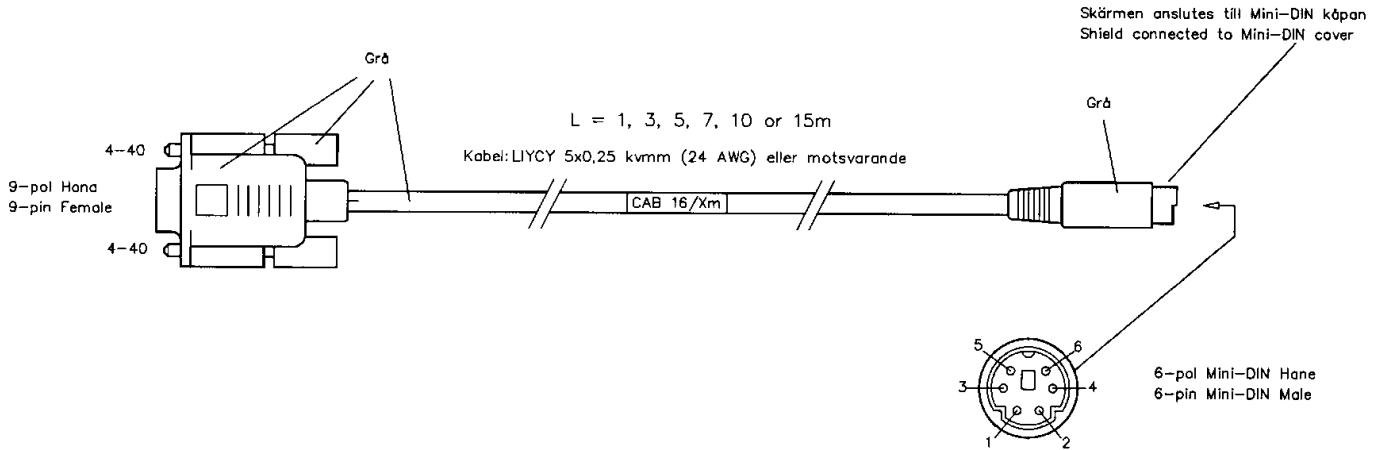

# CAB17 (Stock No 140472)

## E-Series RS422 to Mitsubishi System Q RS232

6 pin MiniDin (male) to 25 pin D-sub (male). The cable length is 3 m. The MiniDin connector is connected to the PLC's CPU RS232 port and the D-sub connector is connected to the RS422 port of the operator terminal.

### (Drawing 03365)

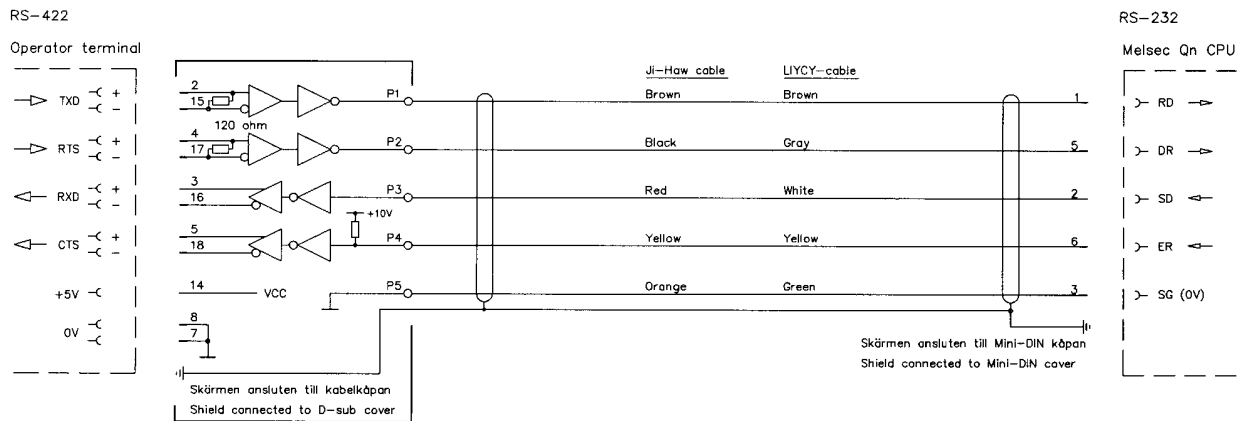
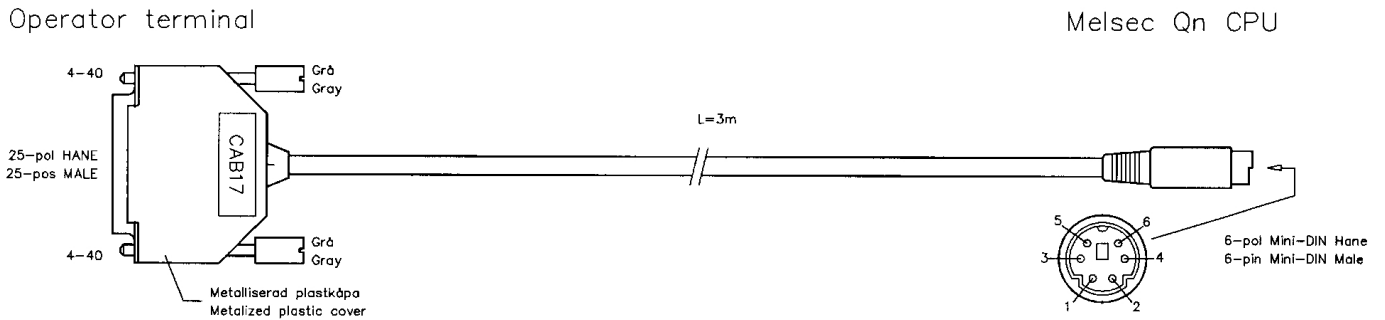

# CAB18 (Stock No 146856=5m length)

E-Series RS422 to A/AnS/FX

25 pin D-sub (male) to 25 pin D-sub (male). The cable is available in the lengths of 3, 5, 7, 10 and 15m.

(Drawing 00757)

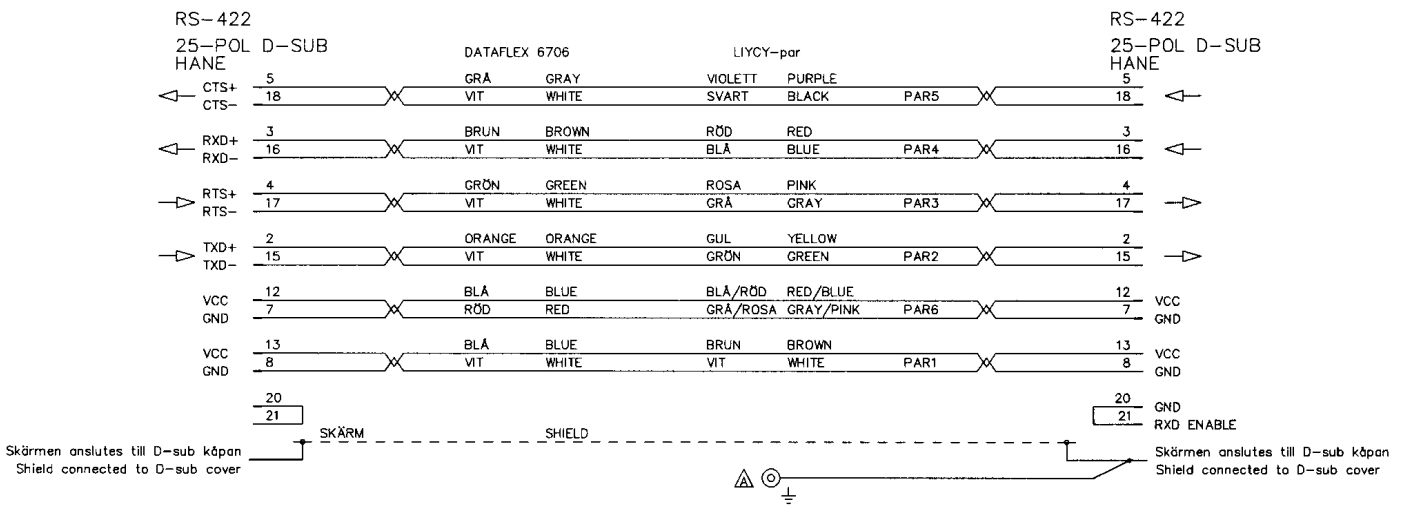
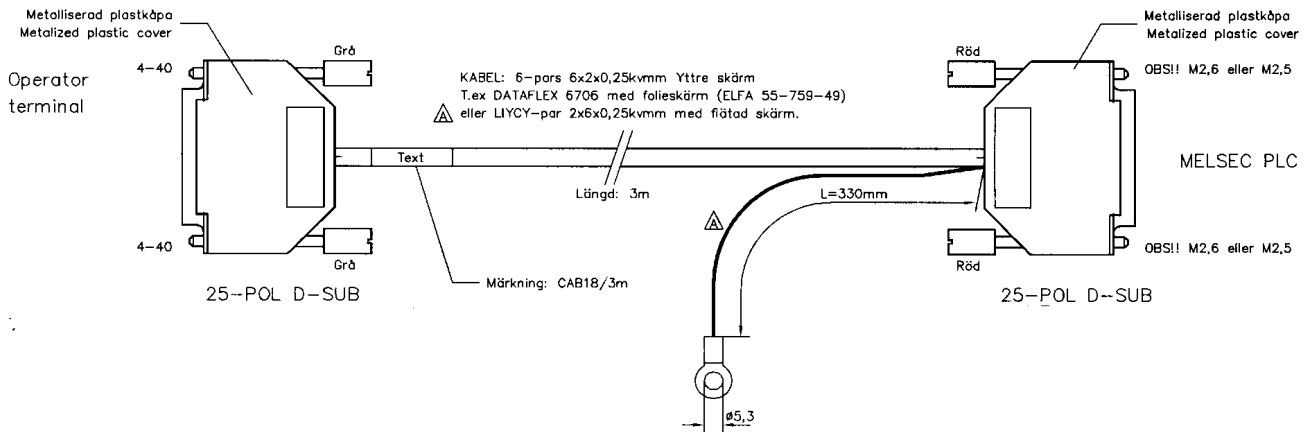

# CAB19 (Stock No 87652 = 5M length)

## E-Series RS422 to FXnN/FXnS/FX3U

25 pin D-sub (male) to 8 pin MiniDin (male). The cable is available in the lengths of 1, 3, 5, 7, 10 and 15 m.

### (Drawing 02161)

K

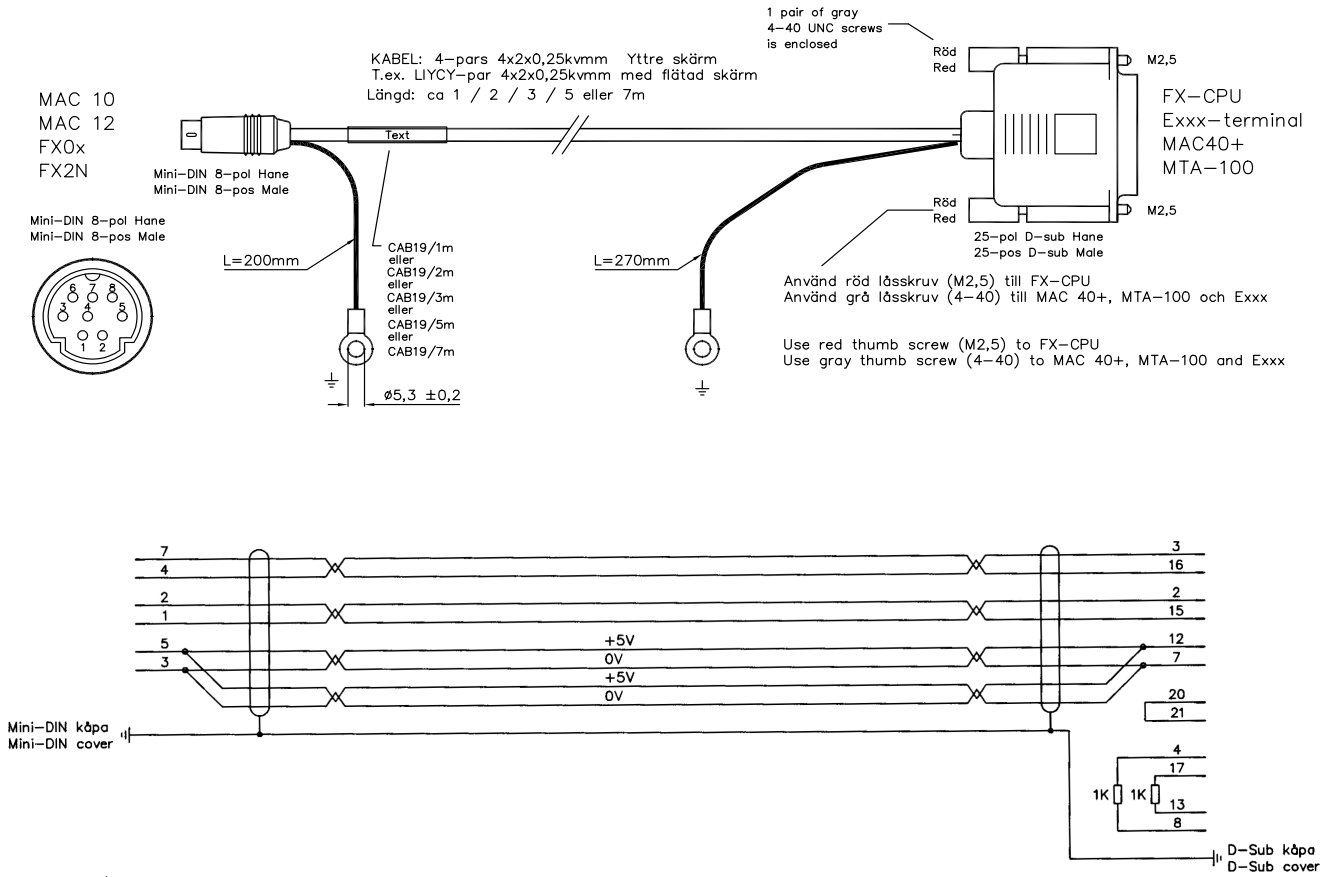

# CAB20 (Stock No 149861)

## E-Series RS422 to SIEMENS S7-200 using a PPI interface

Shielded 25 pin D-sub contact (male) to shielded 9 pin D-sub contact (male). The cable length is 3 m. The 25 pin D-sub connector is connected to the operator terminal and the 9 pin D-sub contact is connected to the SIEMENS S7-200 PPI port (PPI is point to point connection only).

### (Drawing 04480)

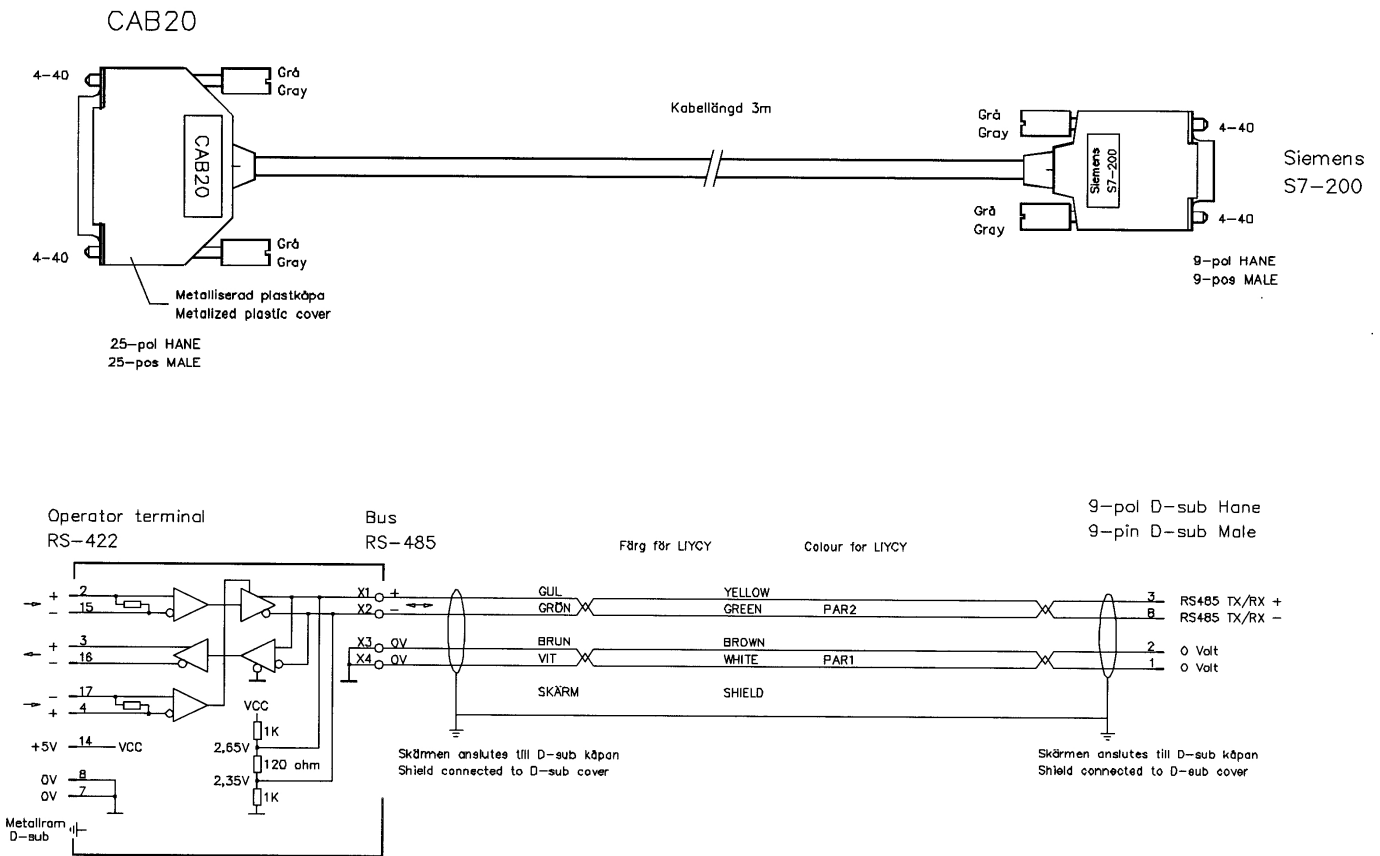

# CAB21 (Stock No 160535)

E-Series RS232 to E-Key16 additional key

Shielded 9 pin D-sub contact (female) to shielded 9 pin D-sub contact (female). The cable length is 3 m.

(Drawing 03321)

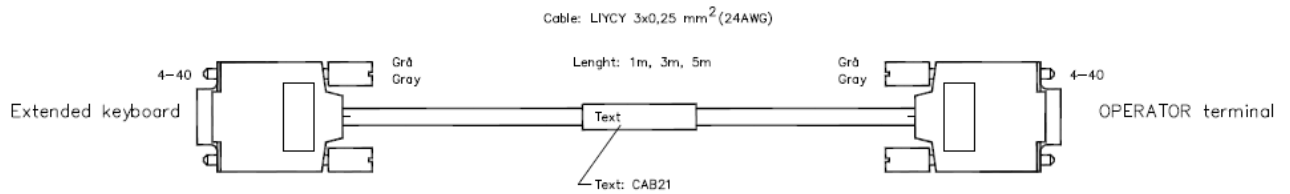
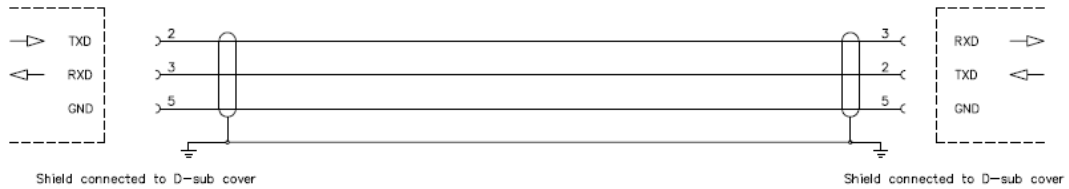

# CAB22

## E-Series RS422 to E-Key16 additional key

Shielded 25 pin D-sub contact (male) to shielded 25 pin D-sub contact (male). The cable length is 3 m.  
 Connect E-Key16 to E-series RS422 port or use the cable to connect two E-Key16 with each other.

### (Drawing 03323)

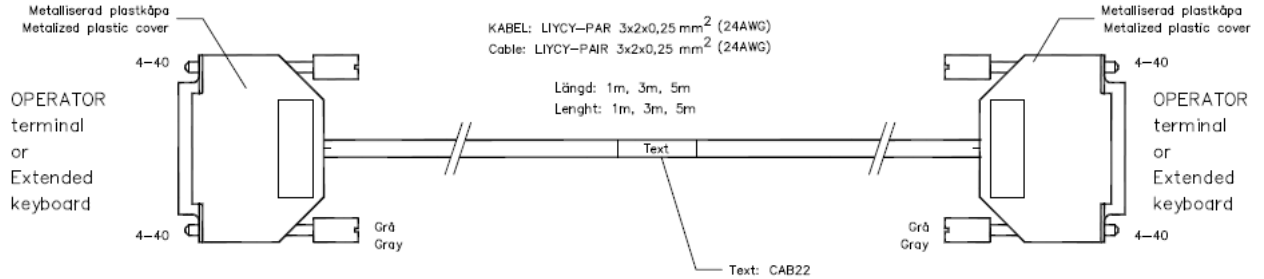
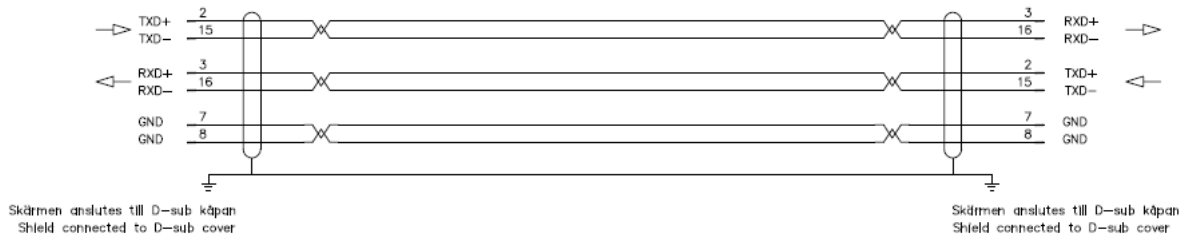



# CAB23

## Extension cable for CAB15 (CANopen Adapter, RS422 to RS422)

Shielded 25 pin D-sub contact (female) on CANopen adapter side to shielded 25 pin D-sub contact (male) on operator terminal side. The cable length is 3 m.

### (Drawing 04353)

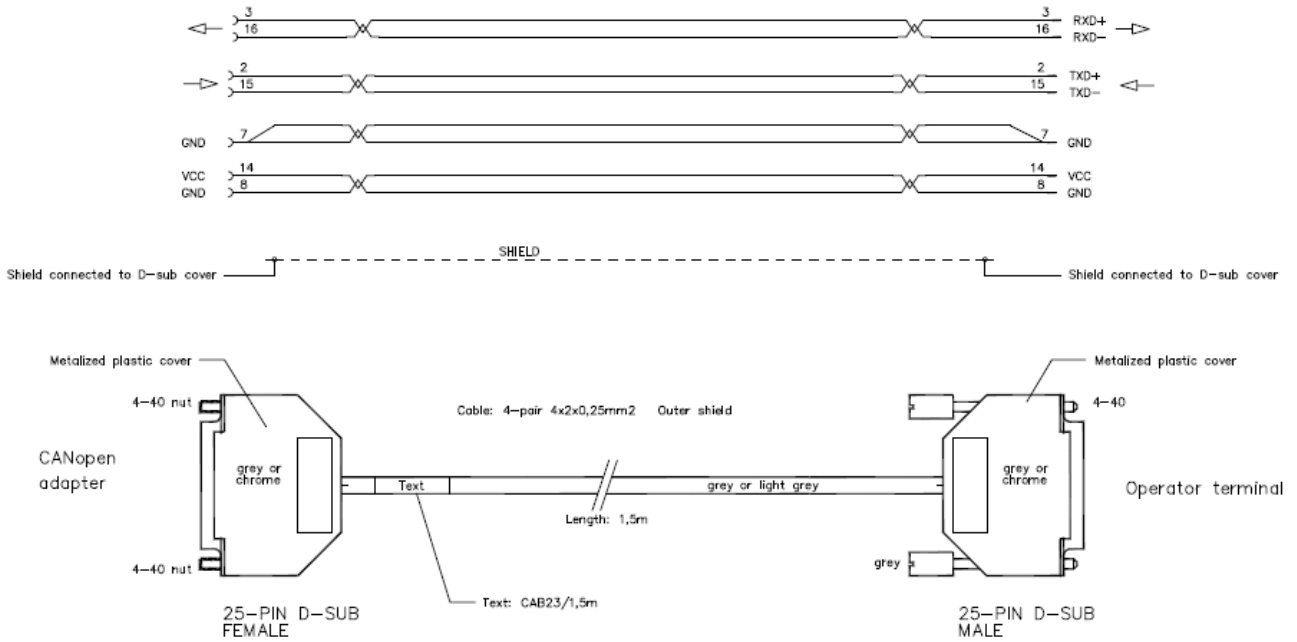

## CAB30 (Stock No 163002)

### RS232 E1000 cable (universal use)

9 pin D-sub (female) to 9 pin D-sub (female). The cable length is 3 m. The CAB30 can be used in six different ways:

1) In this case the CAB30 cable is used as a **programming cable** between a Computer (PC) and the **E1000** operator terminals. The 9 pin D-sub connector is connected to the RS232 port of the operator terminal and the other 9-pin D-sub connector is connected to one of the RS232 communication ports (COM 1/COM 2) of the computer.

2) In this case the CAB30 cable is connected between a **Mitsubishi MELSEC FX1N-232BD, a Mitsubishi MELSEC FX2N-232BD or a FX3U-232BD** board and the RS232 port of the operator terminal.

3) In this case the CAB30 cable is connected between an **Allen Bradley ControlLogix** and the RS232 port of the operator terminal. The following PLCs are supported:  
Allen-Bradley SLC 5/05, Allen Bradley SLC 500, Allen Bradley SLC 5/01, Allen Bradley SLC 5/02, Allen Bradley SLC 5/03  
Allen Bradley SLC 5/04

4) In this case the CAB30 cable is connected between an **B+R 2000 series (Mininet)** and the RS232 port of the operator terminal.

(5) In this case the CAB30 cable is connected between the **MPI port of a SIMATIC S7-300/400** and an operator terminal. The adapter cable CAB11 MPI must be used with the CAB30 (Note: CAB 11 MPI cable length is 1.2 m). The CAB11 D-sub cable is connected to the MPI port of the SIMATIC S7, the other D-sub connector of the adapter is connected to the grey connector of the CAB5. The black connector of the CAB5 is then connected to the RS232C port of the operator terminal.

**Note:** Not all operator terminals support the MPI protocol. Please refer to the driver list in the programming software for further information.

(6) In this case the CAB30 cable is connected between Siemens **SIMATIC S7/-300/400 PLCs** and the RS232C port of the operator terminal. SIMATIC S7/-300/400 must be supplemented with the **communication card CP341**. The black D-sub connector of the CAB5 cable is connected to the RS232C port of the operator terminal and the grey connector of the CAB30 cable is connected to the RS232C port of the communication card CP341.

### (Drawing 05400)

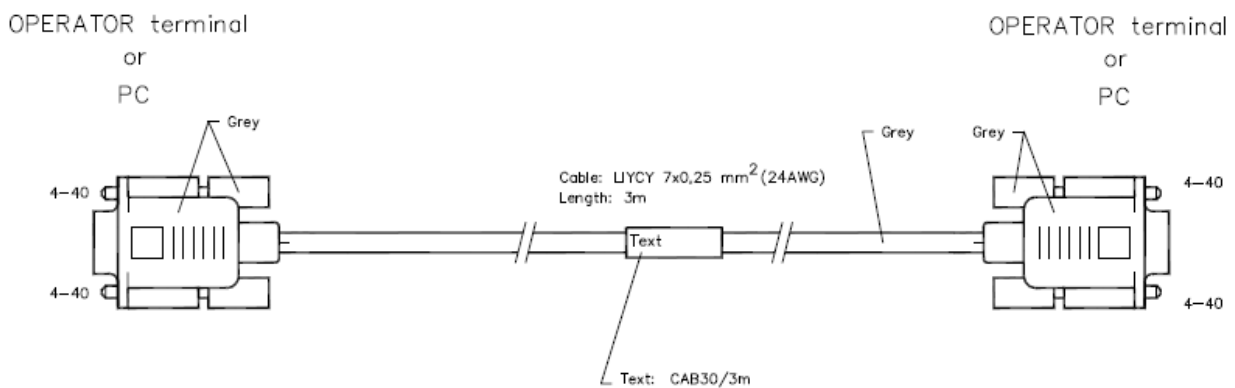
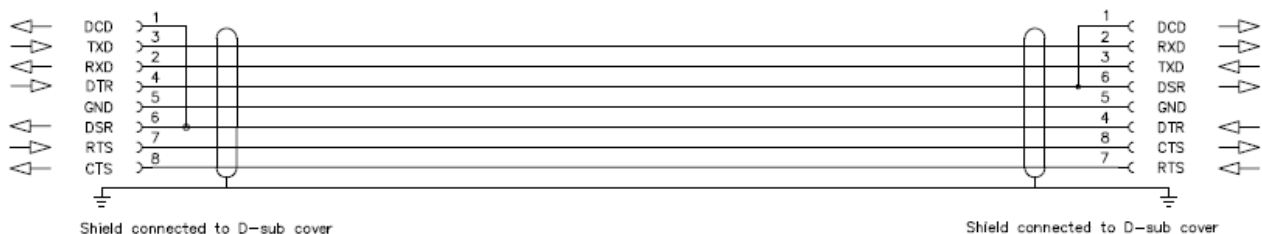

# CAB31 (Stock No 163003)

RS232 E1000 cable to Allen-Bradley Micrologix

9 pin D-sub (female) to MiniDin 8pin on PLC side

## (Drawing 05401)

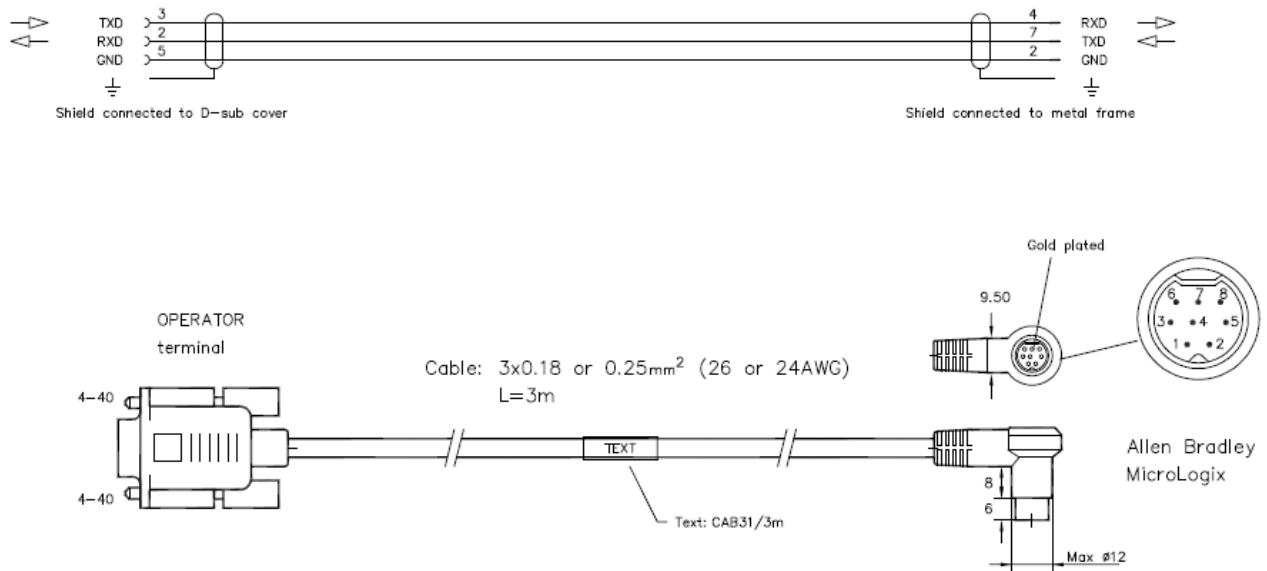

## CAB32 (Stock No 163004)

RS232 E1000 cable to OMRON C/CS1

9 pin D-sub (female) to 9 pin D-sub (male)

(Drawing 05402)

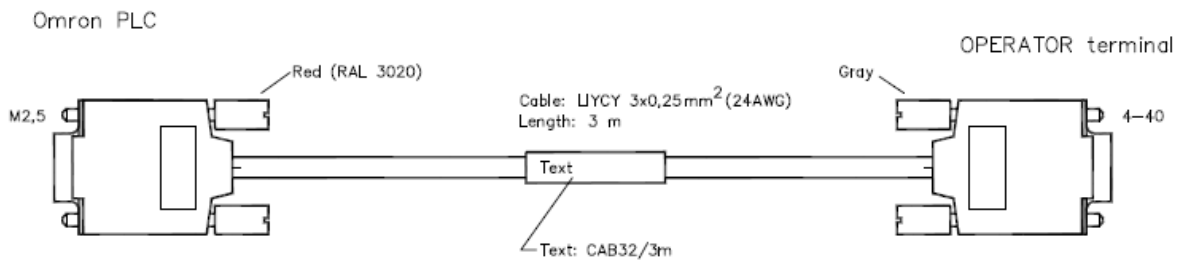
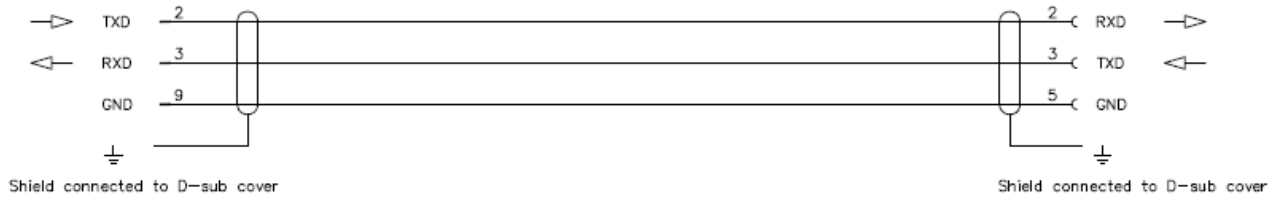

# CAB33 (Stock No 163005)

RS232 E1000 cable to Matsushita FP0/M/2/2SH

9 pin D-sub (female) to MiniDin 5 pin (male) on PLC side

(Drawing 05403)

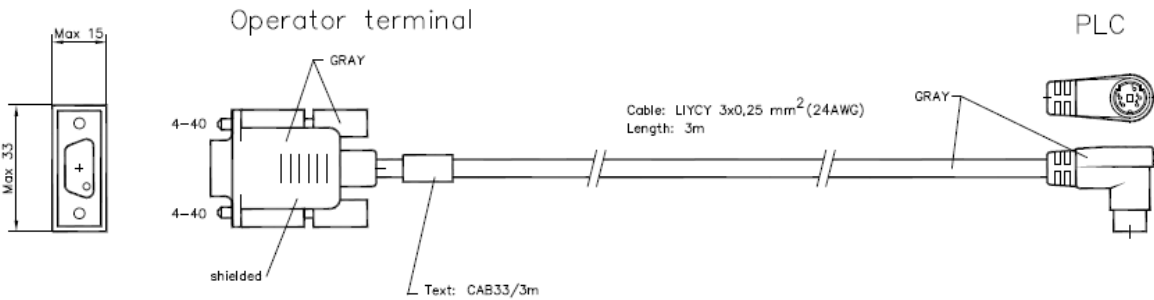
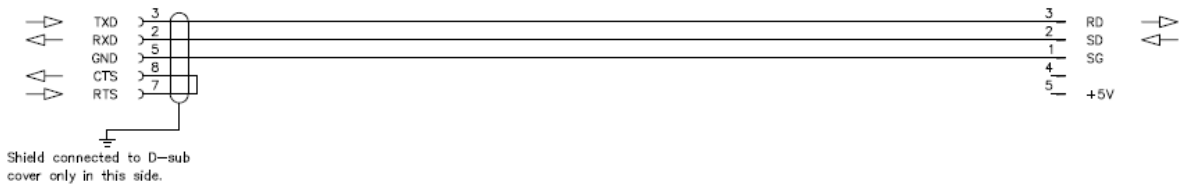

# CAB34 (Stock No 163006 = 3m length, 163007 = 10m length)

## RS232 E1000 cable to Mitsubishi System Q

9 pin D-sub (female) to MiniDin 6 pin (male) on PLC side (CPU Port)

(Drawing 05404)

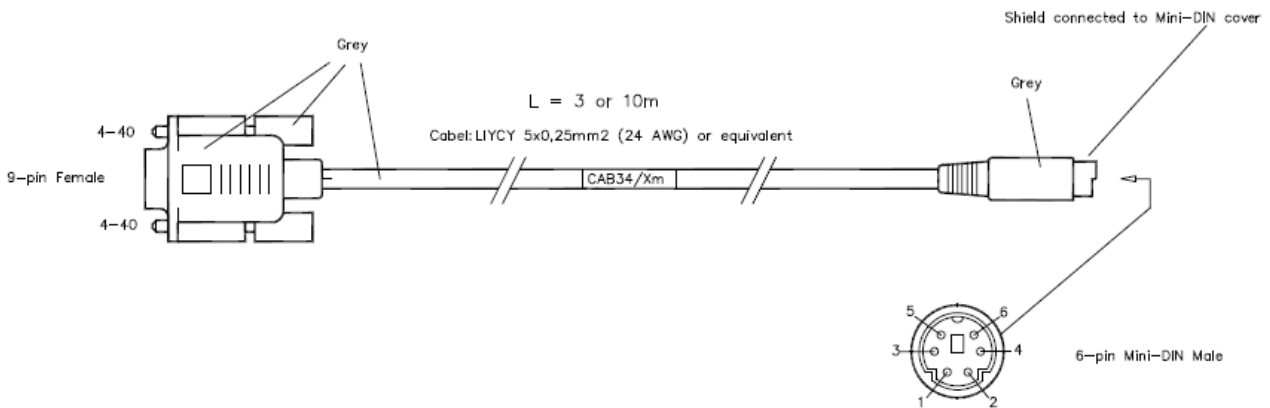
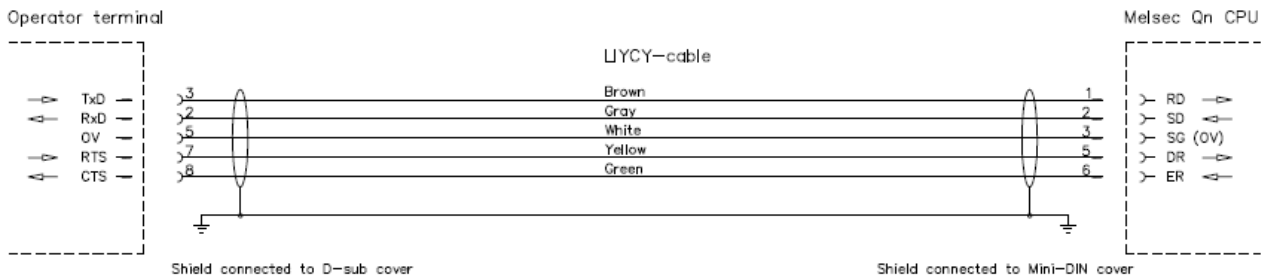

# CAB36

## E1000 RS422 cable to Siemens MPI direct

RS422 D-sub 25 pin male on E1000 operator terminal to MPI connector to connect directly to MPI bus. Cable length 3m.

### (Drawing 05408)

